

FX 110 / FX 120 User Instructions

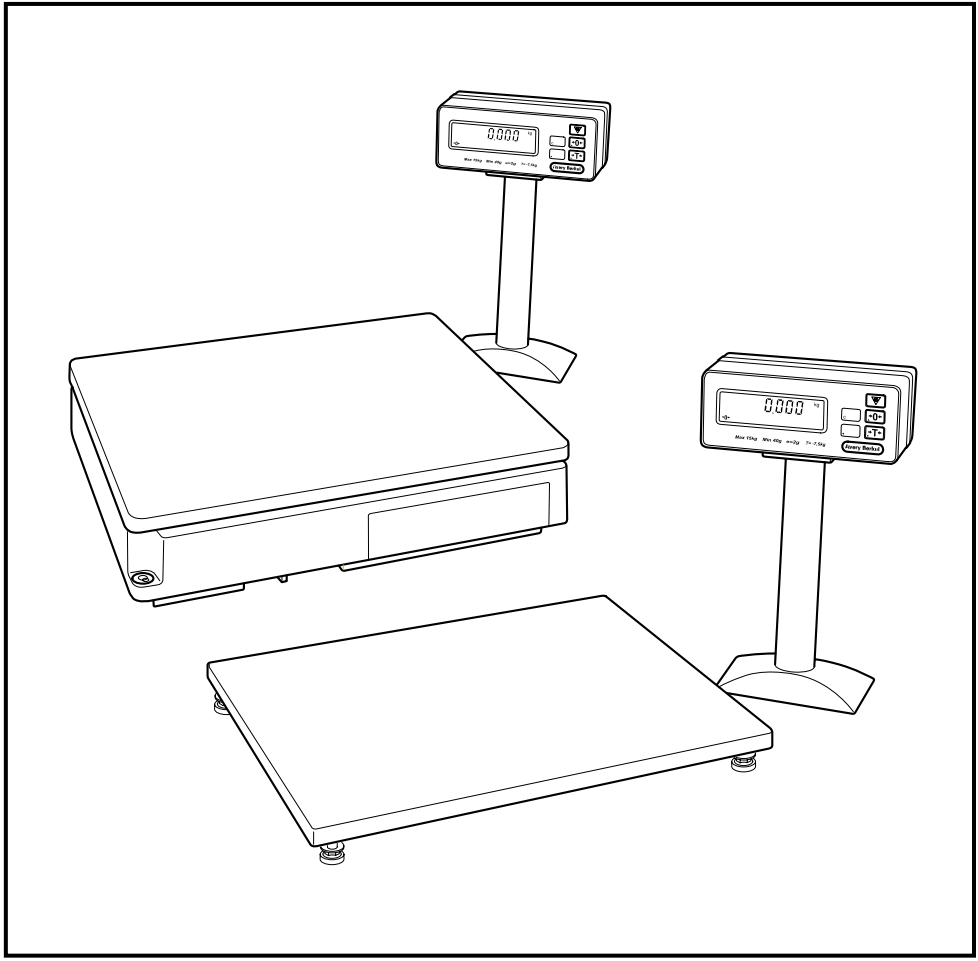

Weight Only Scale



© Avery Berkel Limited 2001. All rights reserved.

The information contained herein is the property of Avery Berkel Limited and is supplied without liability for errors and omissions. No part may be reproduced or used except as authorised by contract or other written permission. The copyright and the foregoing restriction on reproduction and use extend to all media in which the information may be embodied.

Warnings

For your protection, all mains (110V or 230V) equipment used where damp or wet conditions may occur, must be supplied from a correctly fused source and protected by an approved RCD to BS7071 or BS7288 or IEC1008-2-2 BS EN 61008:1995. IF IN DOUBT SEEK ADVICE FROM A QUALIFIED ELECTRICIAN.

To avoid the possibility of electric shock or damage to the machine, always isolate from the mains power supply before carrying out any routine maintenance.

Cleaning the scale

Harsh abrasives, solvents, scouring cleaners and alkaline cleaning solutions, such as washing soda, should not be used especially on the display windows. Under no circumstances should you attempt to wipe the inside of the machine.

The outside of the machine may be wiped down with a clean cloth moistened with water containing a small amount of washing up liquid.

Installation

FX110 only

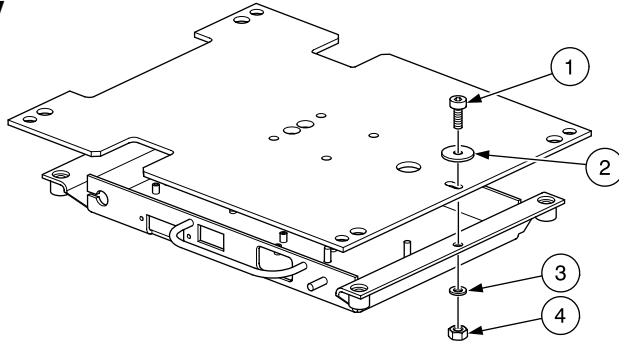

Remove parts 1- 4 before installing the machine

- 1** Make sure that the work surface is firm, steady and free from vibration and draughts.

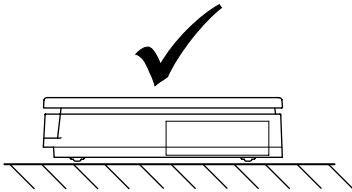

- 2** Hold the scale by the base when picking up. Do not pick up the scale by the weigh plate or cross.

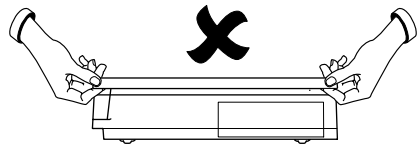
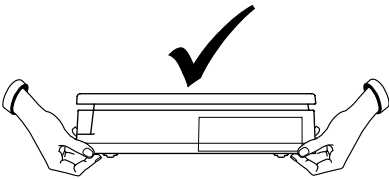

- 3** Adjust the feet if the scale is not level.

FX110

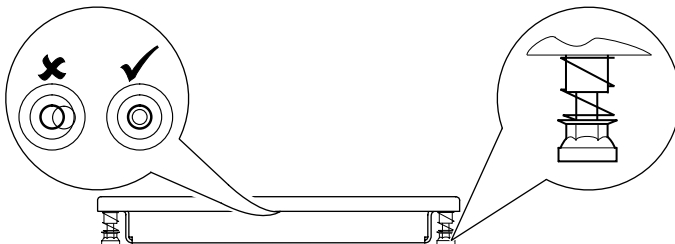

Installation

FX120

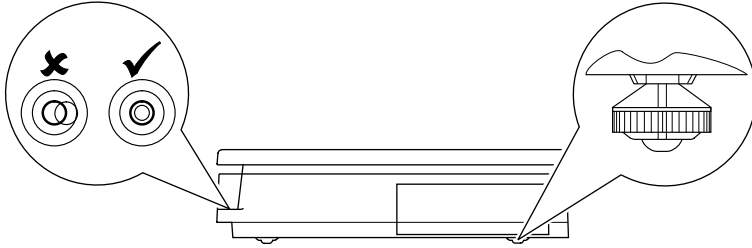

To avoid the risk of RSI (Repetitive Strain Injury) it is important to ensure that the machine is placed on a surface which is ergonomically satisfactory to the user. In cases where usage is prolonged EN614-1 recommends frequent breaks for the user.

FX 110 connections

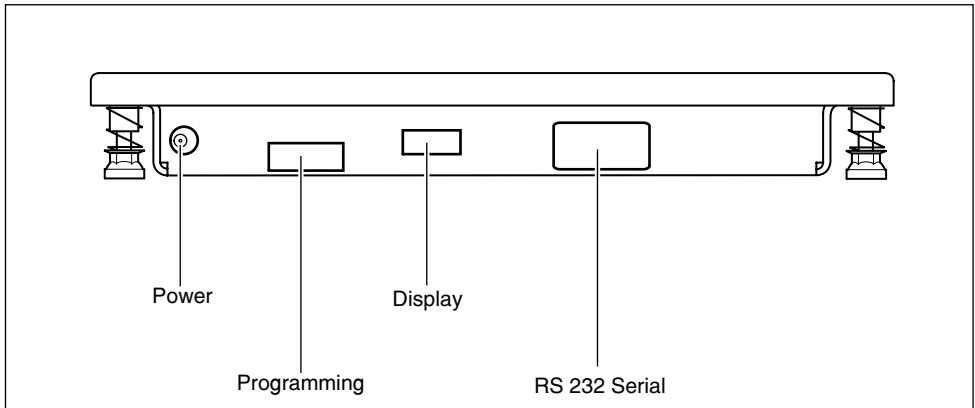

FX 120 connections

1 Remove weigh plate.

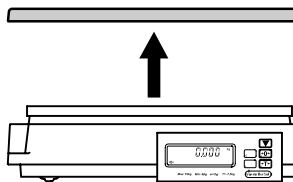

2 Connect power cable.

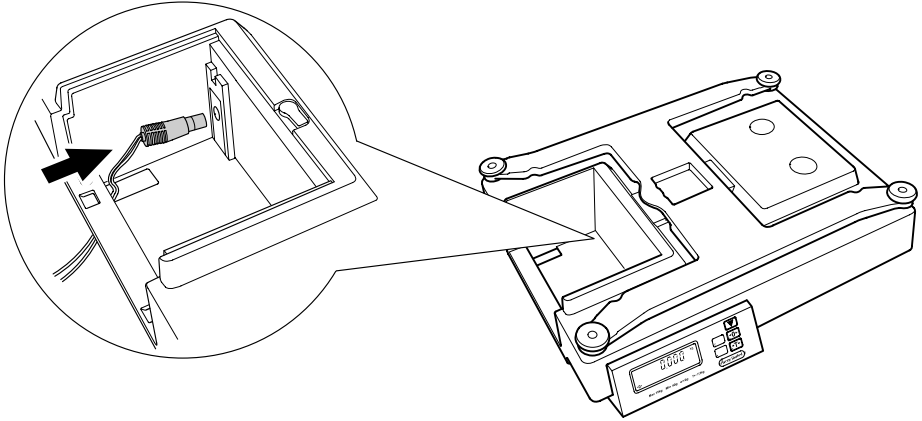

3 To connect remote display.

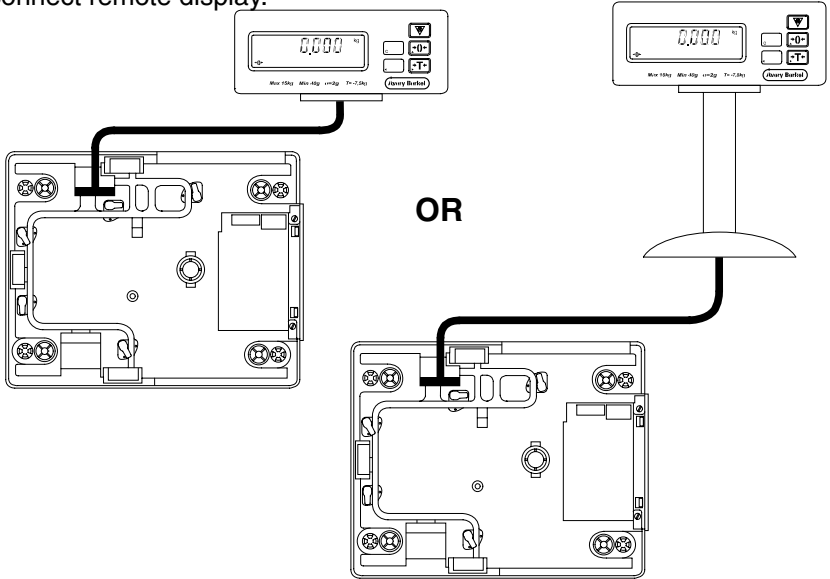

4 Replace the weighplate. Connect to power point.

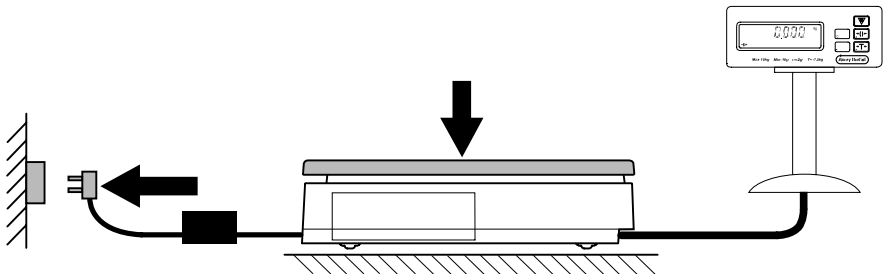

Fitting the FX 120 scale mounted display

1 Make sure the scale is not connected to the power supply and remove weigh plate.

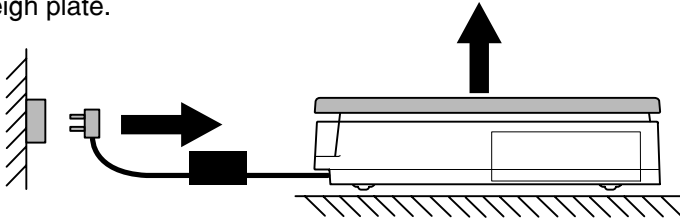

2 Turn over machine and place on a safe, level surface.

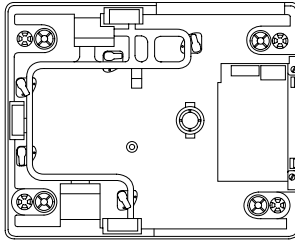

3 Turn the machine round so the required mounting slot is next to the edge of the counter.

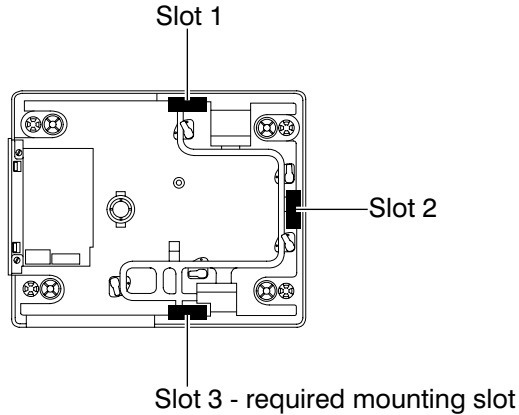

4 Remove the screw in the mounting slot.

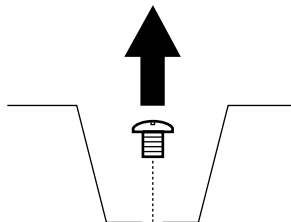

5 Place the mounting bracket into the slot.

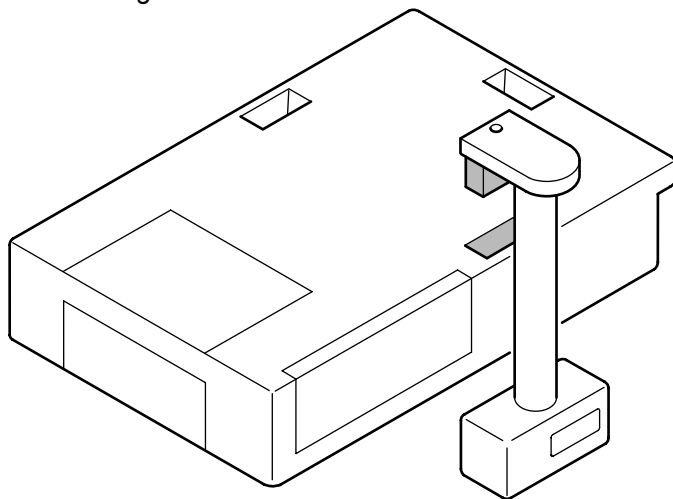

6 Place washer over screw hole and fix with the large replacement screw.

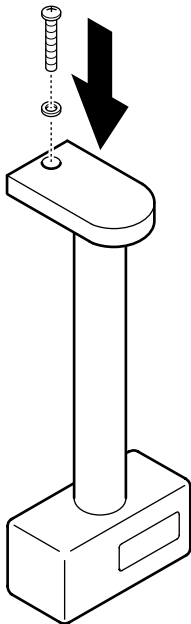

7 Refer to the drawings on the following pages and:

- Plug the display cable into the base.
- Feed the slack cable round the base.
- Secure the cable clips.

8 Place machine upright.

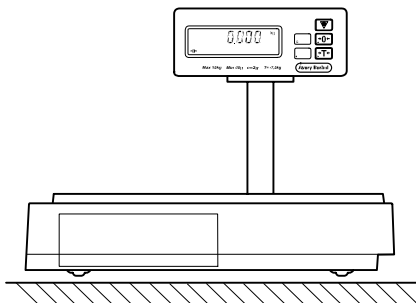

9 Replace the weigh plate. Connect to power point.

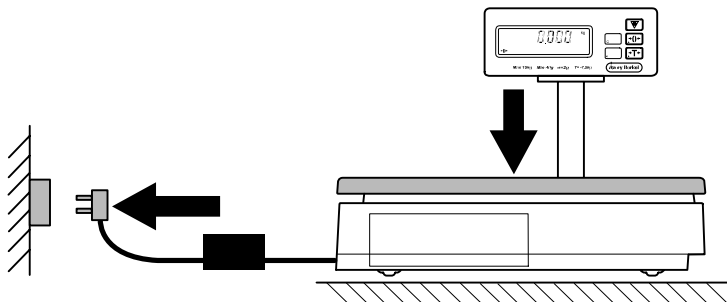

Caution: Do not lift the scale by the column display or the weighplate.

Cable route: single display

Cable from slot 3

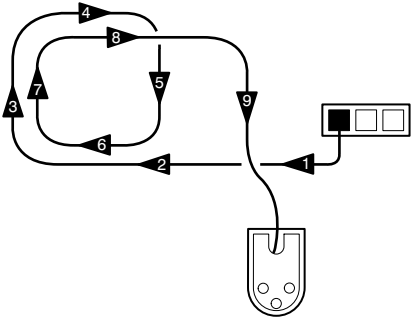
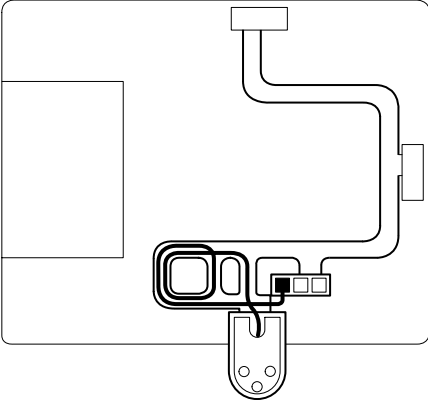

Cable from slot 2

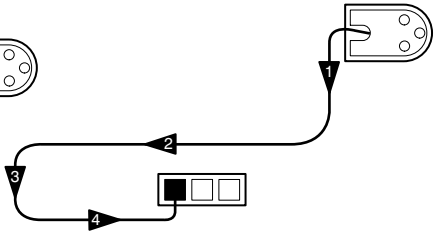
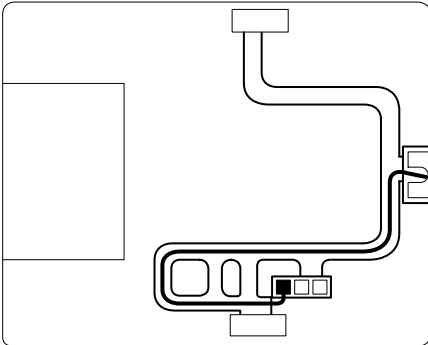

Cable from slot 1

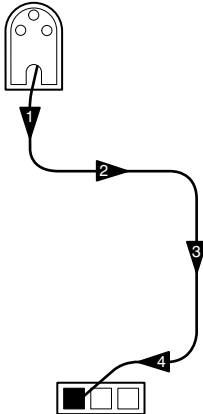
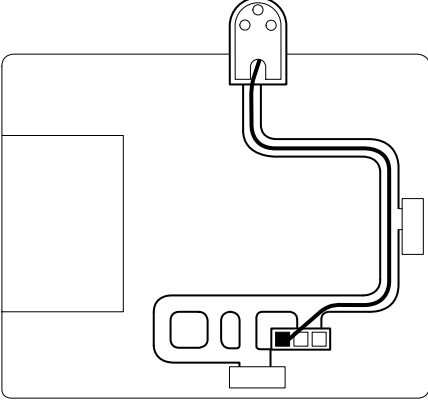

Cable route: dual display

Cable from slot 3

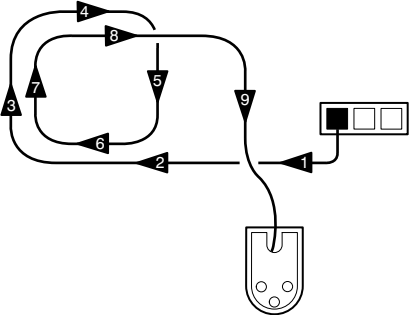
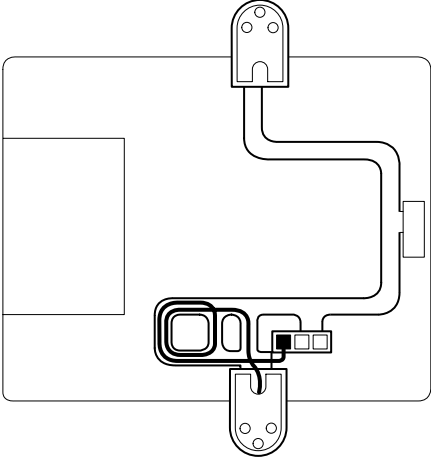

Cable from slot 1

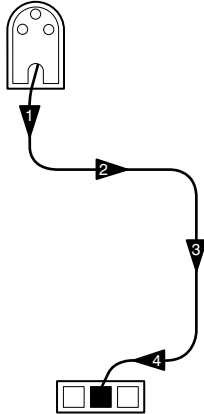
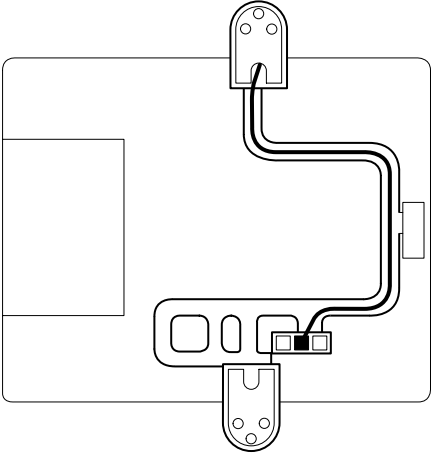

Cable route: dual display

Cable from slot 2

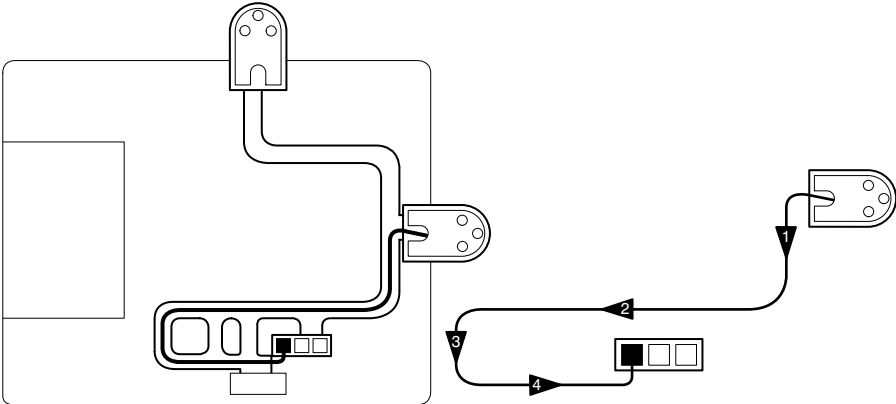

Cable from slot 1

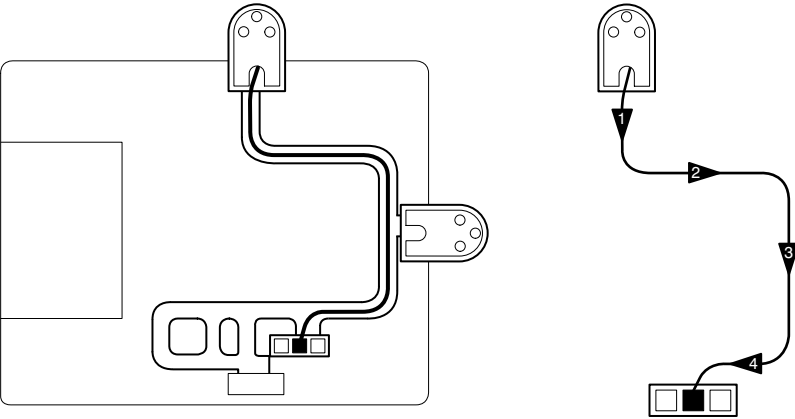

Cable route: dual display

Cable from slot 2

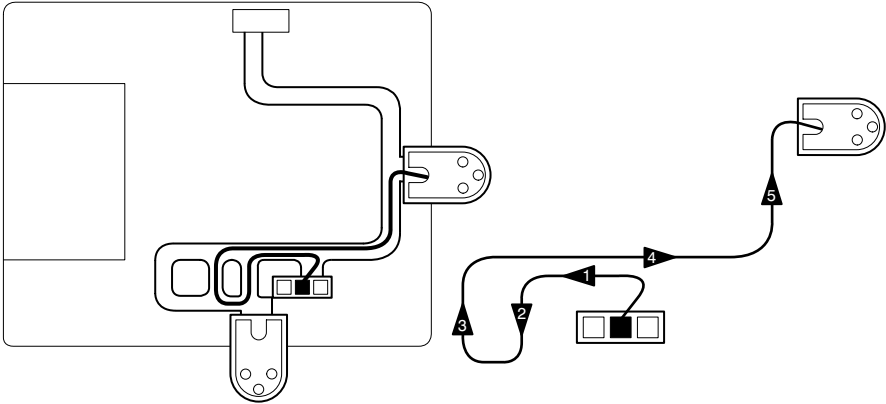

Cable from slot 3

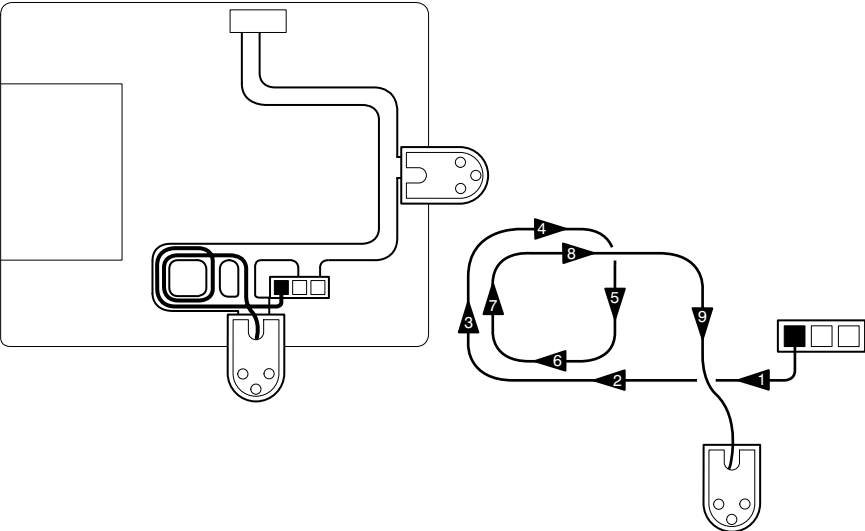

Securing the cable clips

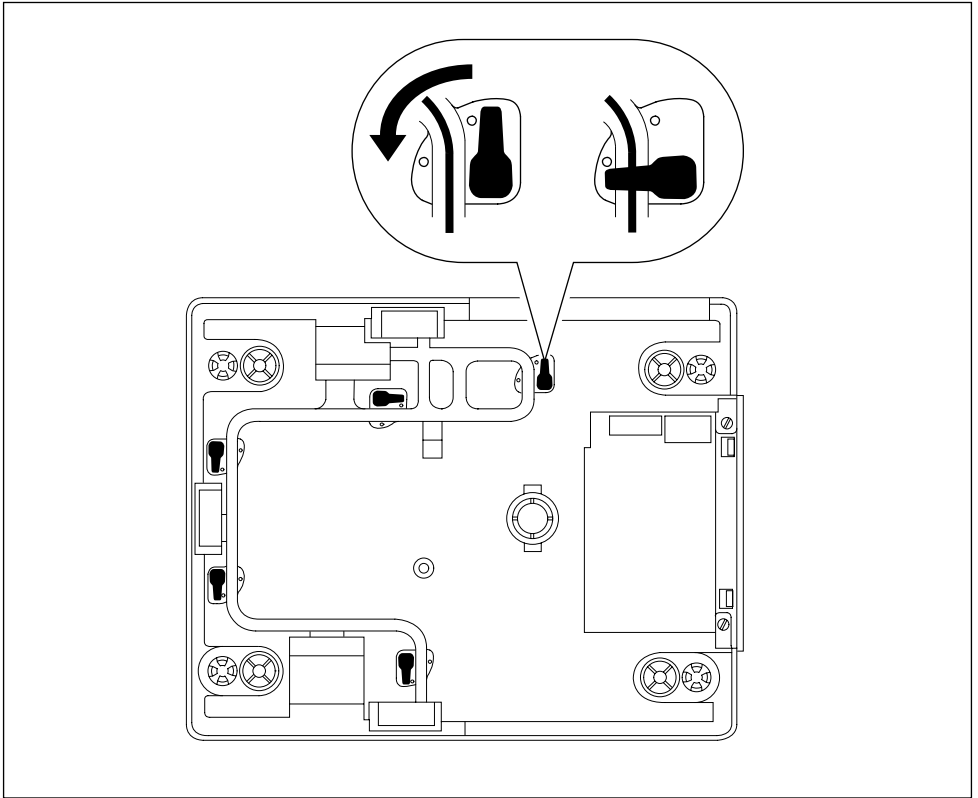

FX 120 battery operation

Note: Battery operation is not available on the FX110

Plug the battery pack into the scale (use 6 x 1.5v 2'D' size cells) and place the pack into the recess. Replace the cover and weighplate.

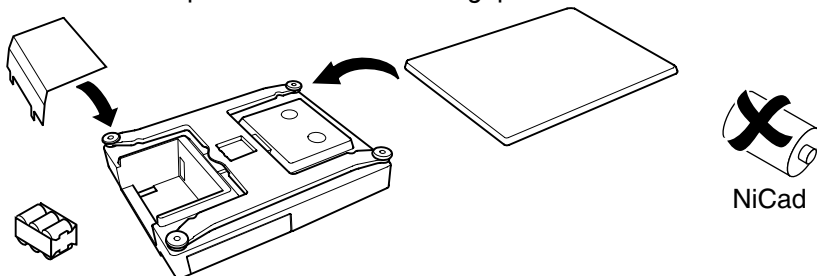

Caution: To avoid damage to the scale caused by leaking batteries, remove flat or damaged batteries immediately.

Please note: Rechargeable NiCad batteries are not suitable for this application due to their inherent short circuit thermal characteristics which can adversely affect the performance of the scale.

When you see the  symbol flashing on the display (or Battery LED flashing), then you must either replace the batteries (or recharge the rechargeable battery).

Using a rechargeable battery pack - Plug the rechargeable battery pack into the scale and place the pack into the recess. Replace the cover and weighplate.

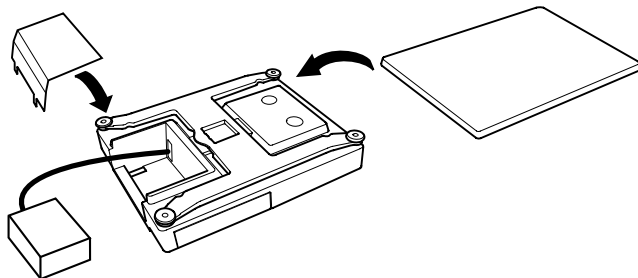

Recharging the battery pack - Plug the mains cable into the socket located on the base of the scale, then switch on using the mains ON/OFF switch.

Note: You can still use the scale while the battery is being charged.

Error messages

F 30

If a persistent error message appears or the scale locks up, disconnect then reconnect the scale to the power supply. If the scale remains inoperative, contact your authorised service agent.



Temporary
error



Weight
unsteady



Balance
failed



Under
range



Over
range

Error codes:

- F 10 Battery failure.
- F 11 Power supply voltage is too high.
- F 30 Memory checksum invalid.
- F 35 Prohibited function.
- F 36 Prohibited scale capacity.

Contact your service agent if you see any other F messages.

- E 120 Tare weight unsteady.
- E 121 Tare too heavy.
- E 122 Tare already in operation.
- E 123 Cannot use EPOS tare.
- E 124 Mismatch between EPOS and scale tare increments.
- E 130 Unit price not accepted.
- E 131 Scale has not returned to zero between EPOS transactions.

Using the scale

Testing the display

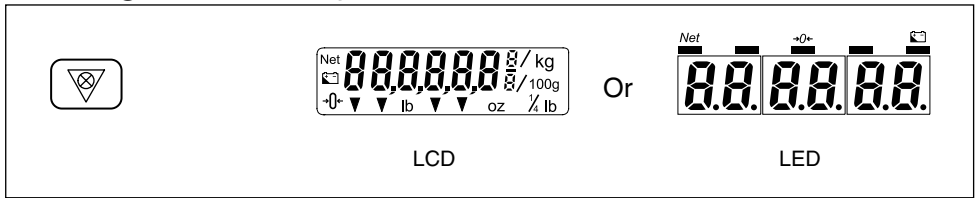

Displaying service information

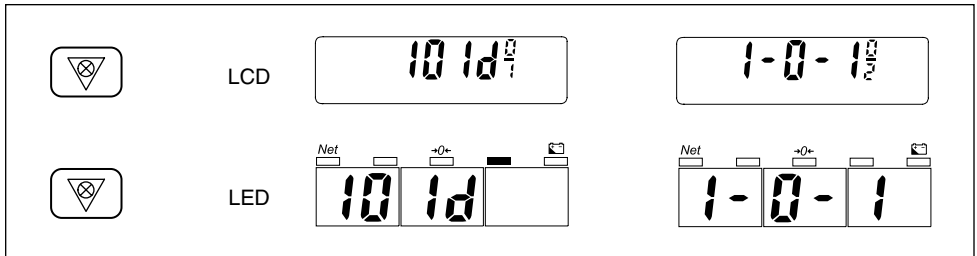

Resetting the machine

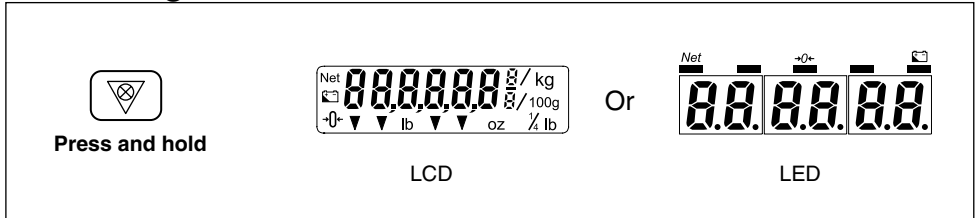

Selecting sleep mode

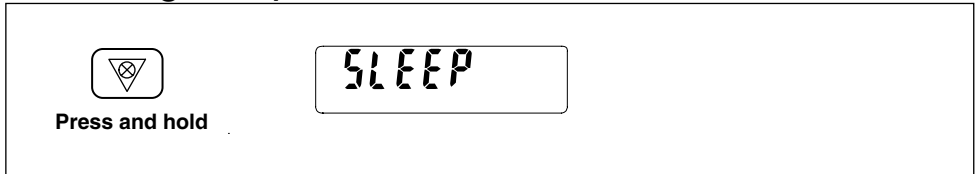

Waking up the scale

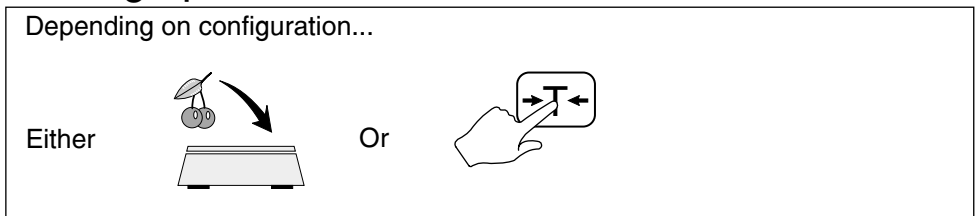

Zeroing the scale

Make sure that the scale is at zero before weighing any goods.

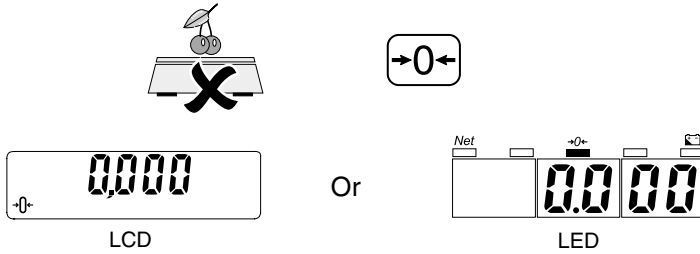

Weighing goods

Place the goods onto the scale.

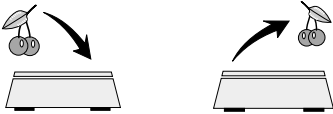

Using tares

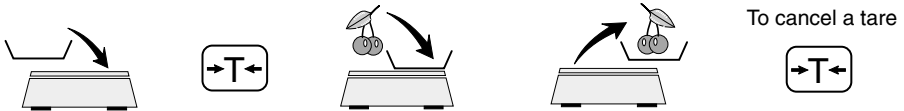

Cumulative tare

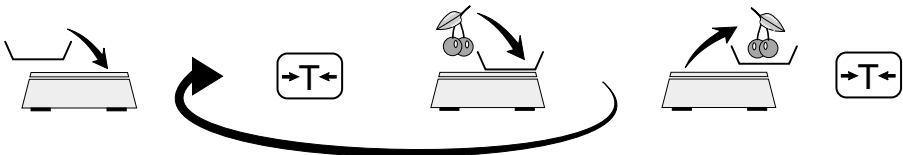

Repeat until all the goods have been weighed.

Management Mode

Entering management mode

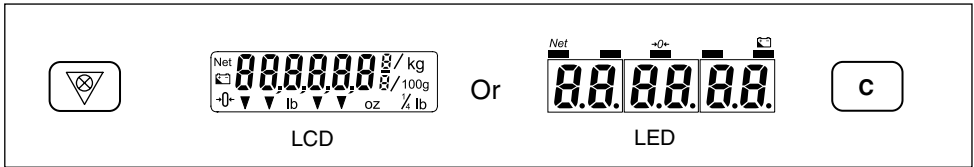

Navigating management mode

Branch – 12.95 – Sub-branch
 | – Value

For Example:

```

  | Branch (12)
  |   | Sub-branch (98)
  | Branch (13)
  |   | Sub-branch (00)
  |   | Sub-branch (01)
  
```



Go to the next branch (press and hold)
 Go to next sub-branch



Go to the previous branch (press and hold)
 Go to previous sub-branch



Sets the value to 0 enabling you to display a new value
 Return to Branch 00 (press and hold)



Displays the value. Press again to re-display
 the branch / sub-branch

After clearing a value to be changed each key press
 increments the value displayed. Pressing and holding
 the key increments the value by 10.

Note: After changing a value, you must
 go to the next branch to accept the value.



Exit management mode

Press and hold

Example: turn the keyboard bleeper off and change the backlight time to 5 seconds.

0.00 [Right Arrow] 19.00 [Right Arrow] 19.01 [Up Arrow] 1 [C] 0
 Press and hold

[Right Arrow] 20.00 [Up Arrow] 4 [C] 0 [Up Arrow] 1
 Press and hold

[Right Arrow] 29.00 [Triangle and X] [Right Arrow]
 Press and hold Press and hold

Switching the bleeper alarm on/off

Go to branch 19, Sub-branch 00

19.00 0 = Off
| 1 = On

Switching the keyboard bleeper on/off

Go to branch 19, Sub-branch 01

19.01 0 = Off
| 1 = On

Target bleep

Branch 19, Sub-branch 02 - Not applicable for this machine.

Error bleeper

Go to branch 19, Sub-branch 03

19.03 0 = Off
| 1 = On

Changing the bleeper volume

Go to branch 19, Sub-branch 04

19.04 0 = Quiet
| 1 = Loud

Changing the backlight time

Go to branch 20, Sub-branch 00

20.00 0 = always off
| 1 = 5 seconds
 2 = 1 minute
 3 = 5 minutes
 4 = always on

Changing the sleep time

Go to branch 20, Sub-branch 01

20.01 0 = none
| 1 = 1 minute
 2 = 5 minutes
 3 = 30 minutes

Changing the duration of a 'Long' press (press and hold)

Go to branch 29, Sub-branch 00

29.00

200

Enter a value in units of 10 milliseconds (50 -255).

For example :

200 = 2 seconds

150 = 1½ seconds

100 = 1 second

Enabling key timeout

Go to branch 74, Sub-branch 01

74.01

1

0 = Disabled

1 = Enabled

Changing the timeout period

Go to branch 74, Sub-branch 02

74.02

20

Enter a value in units of 10 milliseconds (1-255).

For example :

200 = 2 seconds

150 = 1½ seconds

100 = 1 second



Declaration of Conformity

The non-automatic weighing instrument

Manufacturer Type Number of EC type approval certificate	Avery Berkel FX 110 UK 2625
--	-----------------------------------

Manufacturer Type Number of EC type approval certificate	Avery Berkel FX 120 T5532
--	---------------------------------

Corresponds to the requirements of the following EC directives:

Non-Automatic Weighing Instruments Directive	90/384/EEC*
EMC Directive	89/336/EEC
Low Voltage Directive	73/23/EEC
The applicable harmonised standards are:	EN 45 501* EN 50 081-1 EN 60 950

EMC Compliance

This is a class A product. In a domestic environment, this product may cause radio interference in which case the user may be required to take adequate measures.

*This declaration is only valid if the non-automatic weighing instrument was verified by the manufacturer or with a certificate of conformity issued by a notified authority.

A copy of the original signed declaration for this instrument is available from:
Foundry Lane, Smethwick, West Midlands, England. B66 2LP



Email: sales@averyberkel.com
Info: info@averyberkel.com
Internet: <http://www.averyberkel.com>